

# LED Helos Panel



## Product Spec:

Product Code	Dimension L*W*H [mm]	Power [W]	Input Voltage [V]	Efficiency [lm/W]	Color Temp[K]	CRI	Beam Angle	IP	LED Chip
ALPR320-24W	∅320*45mm	24W	AC220-240V	75-90lm/W	3000K-6500K	CRI95	110°	IP40	Epistar4014
ALPR320-24W	∅320*45mm	24W	AC220-240V	85-100lm/W	3000K-6500K	CRI80	110°	IP40	Epistar4014
ALPR520-40W	∅520*41.5mm	40W	AC220-240V	75-90lm/W	4000K-6000K	CRI95	110°	IP40	Epistar4014
ALPR520-40W	∅520*41.5mm	40W	AC220-240V	85-100lm/W	4000K-6000K	CRI80	110°	IP40	Epistar4014

## Dimension(mm):

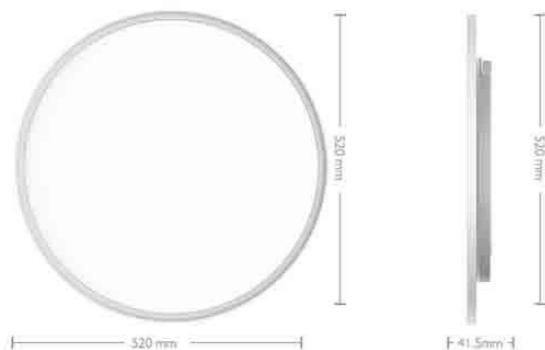

# LED Helos Panel

## Details:

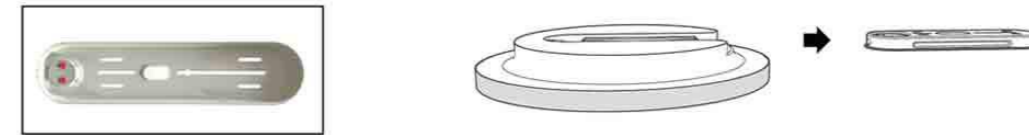

## Installation:

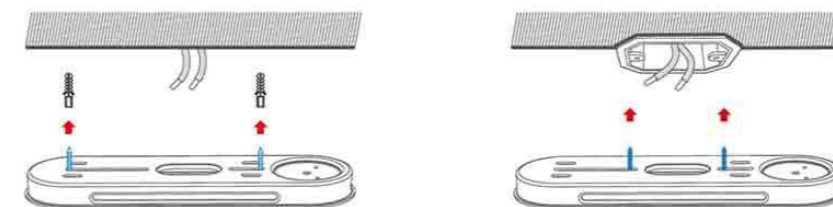

Self-tapping screws \* 2



Expansion tube\* 2



Metric screw \* 2



## Beam Angle:

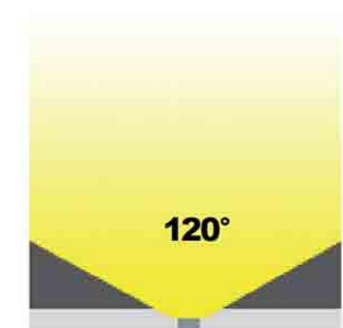

# LED Round Slim Series

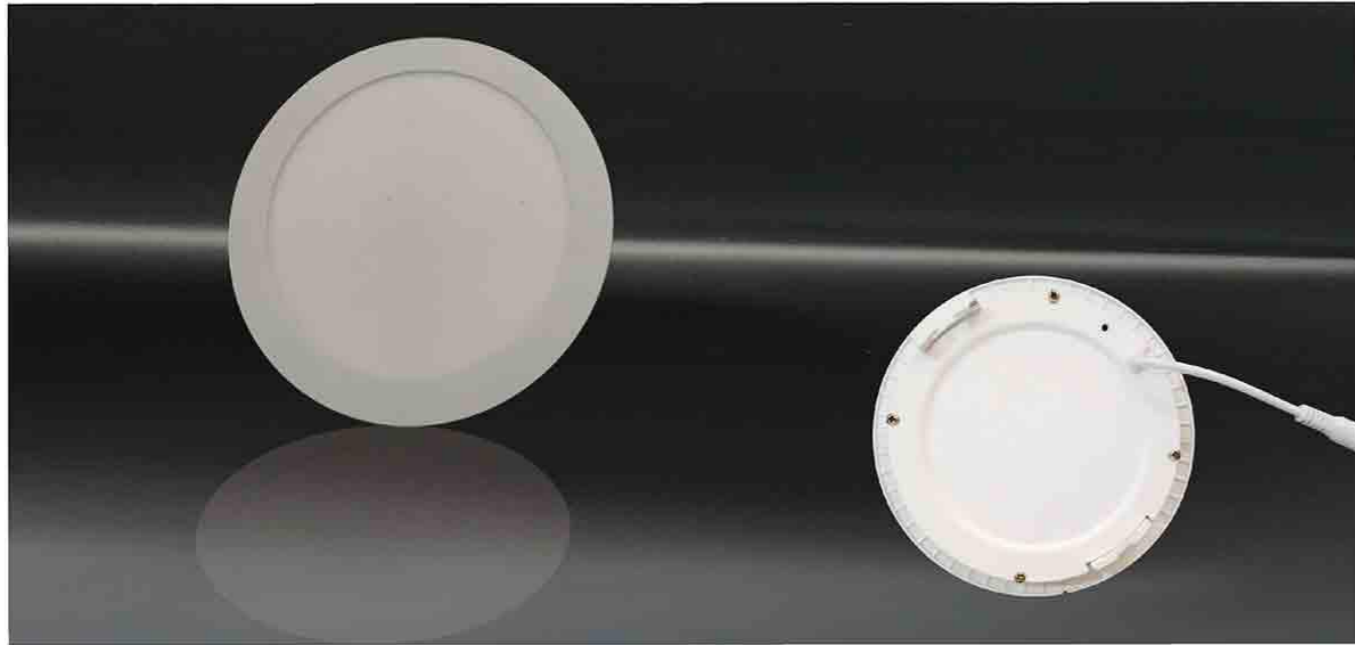

## Product Spec:

Product Code	Dimension L*W*H [mm]	Cut-Out Dia [mm]	Power [W]	Input Voltage [V]	Efficiency [lm/W]	Color Temp[K]	CRI	Beam Angle	UGR	LED Chip
ALPR150-S01-9WK1	Φ150*12mm	Φ135mm	9W	AC100-240V	80lm/W ±10%	3000K-6000K	≥ 80	120°	19<UGR<23	SMD2835
ALPR170-S01-12WK1	Φ170*12mm	Φ155mm	12W	AC100-240V	90lm/W ±10%	3000K-6000K	≥ 80	120°	19<UGR<23	SMD2835
ALPR190-S01-15WK1	Φ190*12mm	Φ175mm	15W	AC100-240V	90lm/W ±10%	3000K-6000K	≥ 80	120°	19<UGR<23	SMD2835
ALPR225-S01-18WK1	Φ225*12mm	Φ210mm	18W	AC100-240V	90lm/W ±10%	3000K-6000K	≥ 80	120°	19<UGR<23	SMD2835
ALPR340-S01-20WK1	Φ340*12mm	Φ225mm	20W	AC100-240V	90lm/W ±10%	3000K-6000K	≥ 80	120°	19<UGR<23	SMD2835

## Dimension(mm):

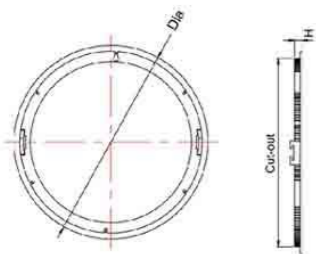

# LED Round Slim Series

## Installation:

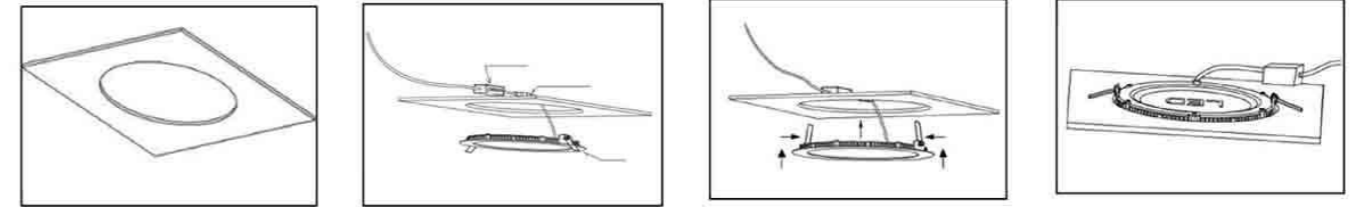

## Luminous Intensity Distribution:

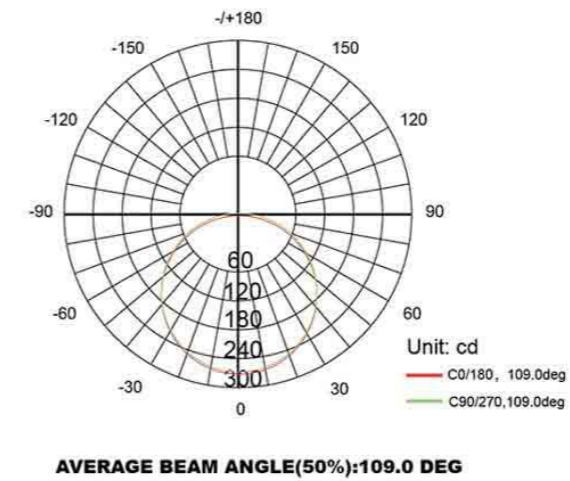

## Beam Angle:

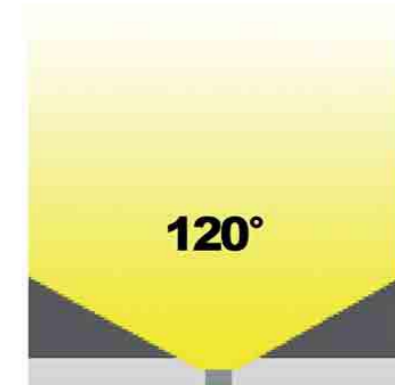

## Tailor Store Dublin





# LED Batten T8



## Product Spec:

Product Code	Dimension L*W*H [mm]	Power [W]	Input Voltage [V]	Efficiency [lm/W]	Color Temp[K]	CRI	Beam Angle	LED Chip
AL-BT81901-2FT-14W	600*50*52mm	14W	AC220-240V	120lm/W	3000K-6500K	≥80	120°	SMD2835
AL-BT81901-2FT-14WPIR	600*50*52mm	14W	AC220-240V	120lm/W	3000K-6500K	≥80	120°	SMD2835
AL-BT81901-4FT-28W	1200*50*52mm	28W	AC220-240V	120lm/W	3000K-6500K	≥80	120°	SMD2835
AL-BT81901-4FT-28WPIR	1200*50*52mm	28W	AC220-240V	120lm/W	3000K-6500K	≥80	120°	SMD2835
AL-BT81901-5FT-36W	1500*50*52mm	36W	AC220-240V	120lm/W	3000K-6500K	≥80	120°	SMD2835
AL-BT81901-5FT-36WPIR	1500*50*52mm	36W	AC220-240V	120lm/W	3000K-6500K	≥80	120°	SMD2835

## Details:



## Dimension(mm):

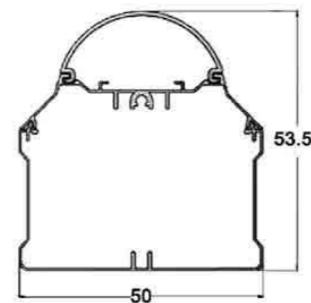

# LED Blackboard Light



Dimension: unit mm

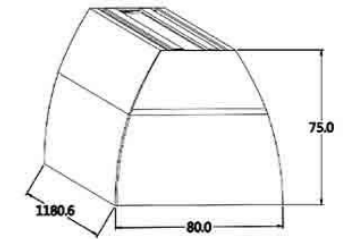

## Product Spec:

Product Code	Dimension L*W*H [mm]	Power [W]	Input Voltage [V]	Efficiency [lm/W]	Color Temp[K]	CRI	Beam Angle	UGR	LED Chip	Drive
AL-Blackboard-6063	1180.6*80*75mm	40W	AC100-240V	85-90LM/W	5000K	>90	20°/lens	UGR<18	SMD2835	TUV Approved

## Beam Angle:

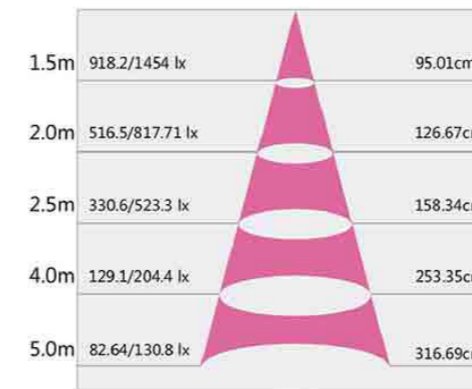

Height: Eavg/Emax      Beam Angle :35.14°

## Luminous Intensity Distribution:

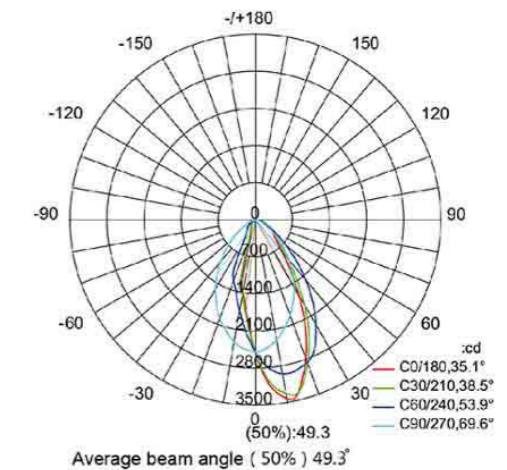



## Single Colour Led Tape

[4.8W per/m]



**DC Output:24VDC/12VDC**

**Diodes:SMD2835/3528**

**Life Span:50000 Hours**

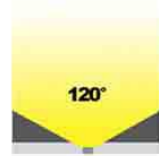

Product Code	Power [W/M]	Diodes Type	IP Rating	CCT-[Lumen/Meter]				Led Qty [LED/M]	CRI	PCB SIZE		
				WW	WW	NW	CW			Cutting points(mm)	Width (mm)	Height (mm)
				2200K	2700K	4000K	6000K					
ALSTP2835-4.8W60sR90P20	4.8	2835	IP20	330	380	410	430	60	>90	100	8	1.4
ALSTP2835-4.8W70sR80P20	4.8	2835	IP20	520	630	660	670	70	>80	100	8	1.4
ALSTP2835-4.8W60sR90P65	4.8	2835	IP65	330	350	380	400	60	>90	100	10.5	4.3
ALSTP2835-4.8W60sR90P68	4.8	2835	IP68	-	310	340	350	60	>90	100	10.5	4.3
ALSTP3528-4.8W60sR80P20	4.8	3528	IP20	-	370	400	420	60	>80	100	8	2.3
ALSTP3528-4.8W120sR80P20	4.8	3528	IP20	-	485	500	510	120	>80	50	8	2.3
ALSTP3528-4.8W120sR80P65	4.8	3528	IP65	-	445	480	485	120	>80	50	10.5	4.3
ALSTP3528-4.8W60sR80P65	4.8	3528	IP65	-	440	470	475	60	>80	100	10.5	4.3
ALSTP3528-4.8W120sR80P68	4.8	3528	IP68	-	385	405	410	120	>80	50	10.5	5.3
ALSTP3528-4.8W60sR80P68	4.8	3528	IP68	-	375	395	400	60	>80	100	10.5	5.3



Details:

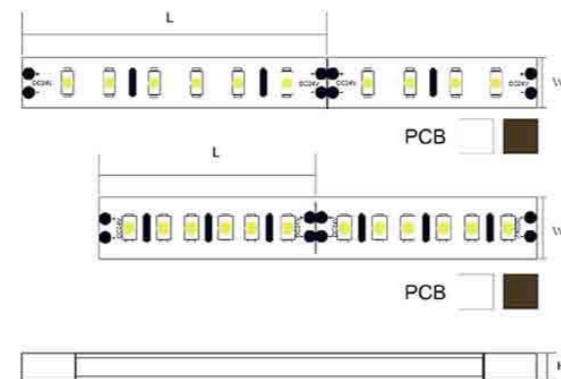

## Single Colour Led Tape

[9.6W per/m]



**DC Output:24VDC/12VDC**

**Diodes:SMD2835/3528**

**Life Span:50000 Hours**



Product Code	Power [W/M]	Diodes Type	IP Rating	CCT-[Lumen/Meter]				Led Qty [LED/M]	CRI	PCB SIZE		
				WW	WW	NW	CW			Cutting points(mm)	Width (mm)	Height (mm)
				2200K	2700K	4000K	6000K					
ALSTP2835-9.6W120sR90P20	9.6	2835	IP20	640	770	840	880	120	>90	50	8	1.4
ALSTP2835-9.6W140sR80P20	9.6	2835	IP20	1040	1230	1230	1290	140	>80	50	8	1.4
ALSTP2835-9.6W120sR90P65	9.6	2835	IP65	600	720	780	820	120	>90	50	10.5	4.5
ALSTP2835-9.6W120sR90P68	9.6	2835	IP68	-	640	700	730	120	>90	50	10.5	5.3
ALSTP3528-9.6W120sR80P20	9.6	3528	IP20	-	865	988	990	120	>80	50	8	2.3
ALSTP3528-9.6W120sR80P65	9.6	3528	IP65	-	845	968	970	120	>80	50	10.5	4.3



Details:

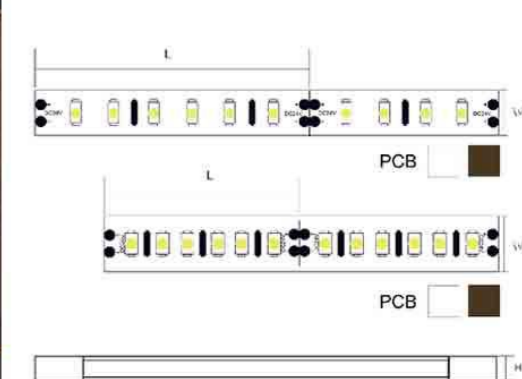



## Single Colour Led Tape

[19.2W per/m]



**DC Output:24VDC/12VDC**

**Diodes:SMD2835/5050**

**Life Span:50000 Hours**

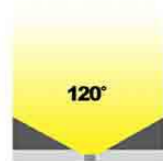

Product Code	Power [W/M]	Diodes Type	IP Rating	CCT-[Lumen/Meter]				Led Qty [LED/M]	CRI	PCB SIZE		
				WW	WW	NW	CW			Cutting points(mm)	Width (mm)	Height (mm)
				2200K	2700K	4000K	6000K					
ALSTP2835-19.2W240sR90P20	19.2	2835	IP20	1300	1500	1630	1720	240	>90	25	10	1.4
ALSTP2835-19.2W120sR90P20	19.2	2835	IP20	1500	1800	1910	1920	120	>90	50	10	1.4
ALSTP2835-19.2W120sR90P65	19.2	2835	IP65	1440	1670	1780	1790	120	>90	50	12.5	4.3
ALSTP2835-19.2W120sR90P68	19.2	2835	IP68	-	1500	1590	1600	120	>90	50	12.5	5.3
ALSTP5050-19.2W60sR80P68	19.2	5050	IP68	-	370	375	380	60	>80	100	14.5	4.8



Details:

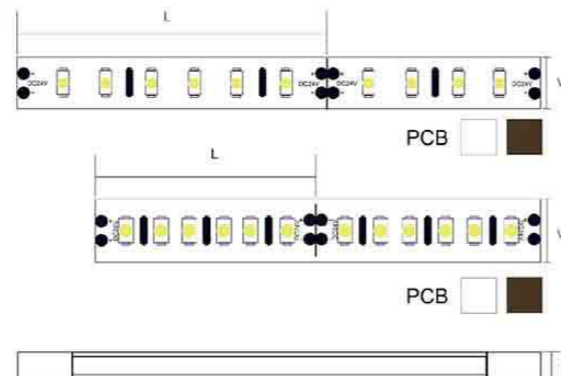

## RGB Colour Led Tape

[7.2W per/m]  
[14.4W per/m]



**DC Output:24VDC/12VDC**

**Diodes:SMD5050**

**Life Span:50000 Hours**



Product Code	Power [W/M]	Diodes Type	IP Rating	Led Qty [LED/M]	RGB			PCB SIZE		
					Red	Green	Blue	Cutting points(mm)	Width (mm)	Height (mm)
					60	150	40			
ALSTPRGB5050-7.2W30sP20	7.2	5050	IP20	30	60	150	40	166.7	10	2.1
ALSTPRGB5050-7.2W30sP65	7.2	5050	IP65	30	55	140	35	166.7	12	4.5
ALSTPRGB5050-7.2W30sP68	7.2	5050	IP68	30	50	120	30	166.7	12.5	5.3
ALSTPRGB5050-14.4W60sP20	14.4	5050	IP20	60	130	330	70	100	10	2.1
ALSTPRGB5050-14.4W60sP65	14.4	5050	IP65	60	120	310	60	100	12	4.5
ALSTPRGB5050-14.4W60sP68	14.4	5050	IP68	60	110	260	60	100	12.5	5.3
ALSTPRGB5050-14.4W96sP65	14.4	5050	IP65	96	120	310	60	62.5	12.5	4.3



Details:

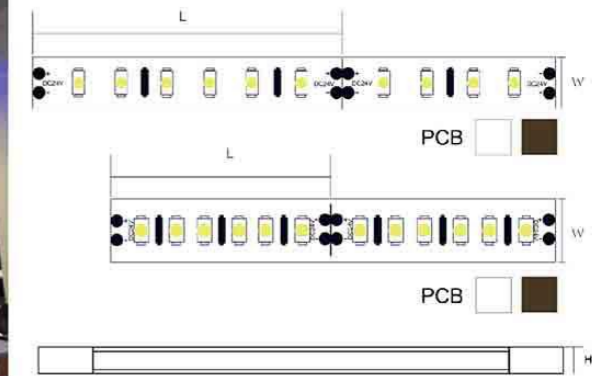



# RGBW Colour Led Tape



**[19.2W per/m]**  
**[14.4W per/m]**  
**[24W per/m]**



**DC Output:24VDC/12VDC**  
**Diodes:SMD5050/3527**  
**Life Span:50000 Hours**

9.2/14.4/24W PER/M

120°

5M/ROI Packing



Product Code	Power [W/M]	Diodes Type	IP Rating	CCT-[Lumen/Meter]				RGB			Led Qty [LED/M]	PCB SIZE		
				WW	WW	NW	CW	Red	Green	Blue		Cutting points(mm)	Width (mm)	Height (mm)
				2400K	2700K	4000K	5000K							
ALSTPRGBW3527-19.2W120sP20	19.2	3527	IP20	310	320	360	380	130	330	70	120	100	10	2.1
ALSTPRGBW5050-19.2W60sP20	19.2	5050	IP20	300	310	340	360	120	330	60	60	100	12	2.1
ALSTPRGBW3527-19.2W120sP62	19.2	3527	IP62	260	270	300	320	110	260	60	120	100	10	3.2
ALSTPRGBW5050-19.2W60sP62	19.2	5050	IP62	250	260	280	300	100	250	50	60	100	12	3.2
ALSTPRGBW3527-19.2W120sP68	19.2	3527	IP68	260	270	300	320	110	260	60	120	100	12.5	5.3
ALSTPRGBW5050-19.2W60sP68	19.2	5050	IP68	250	260	280	300	100	250	50	60	100	14.5	5.3
ALSTPRGBW5050-14.4W60sP20	14.4	5050	IP20	540	620	650	660	70	160	40	60	100	12	2.1
ALSTPRGBW5050-14.4W60sP62	14.4	5050	IP62	450	510	540	550	50	120	30	60	100	12	3.2
ALSTPRGBW5050-14.4W60sP68	14.4	5050	IP68	450	510	540	550	50	120	30	60	100	14.5	5.3
ALSTPRGBW5050-14.4W96sP20	14.4	5050	IP20	-	360	371	380	-	-	-	96	62.5	12	2.1
ALSTPRGBW5050-24W60sP20	24	5050	IP20	-	-	-	60	120	330	60	60	100	12	2.1
ALSTPRGBW5050-24W60sP62	24	5050	IP62	-	280	-	350	100	250	50	60	100	12	3.2
ALSTPRGBW5050-24W60sP68	24	5050	IP68	280	-	-	300	100	250	50	60	100	14.5	5.3

### Details:

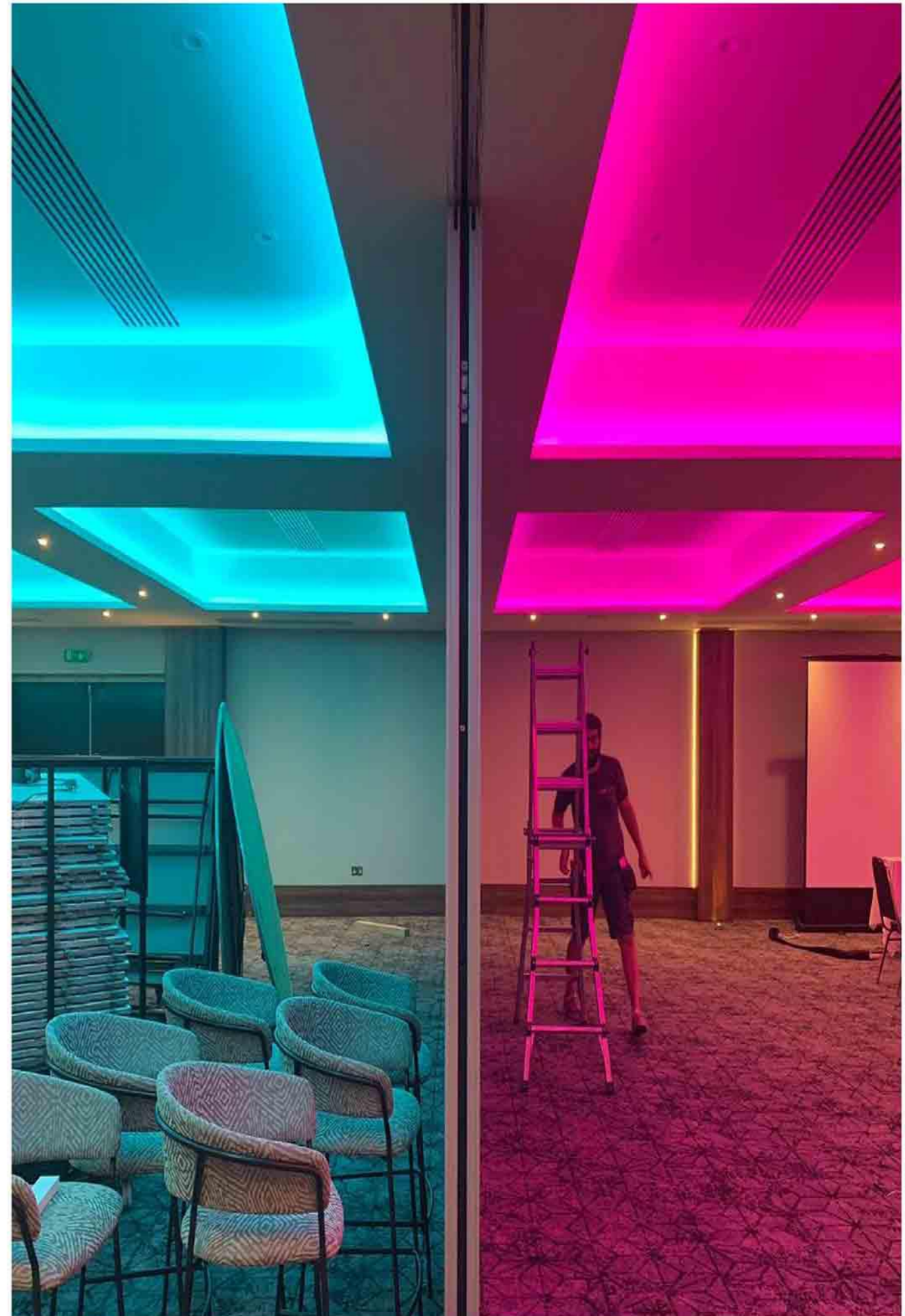
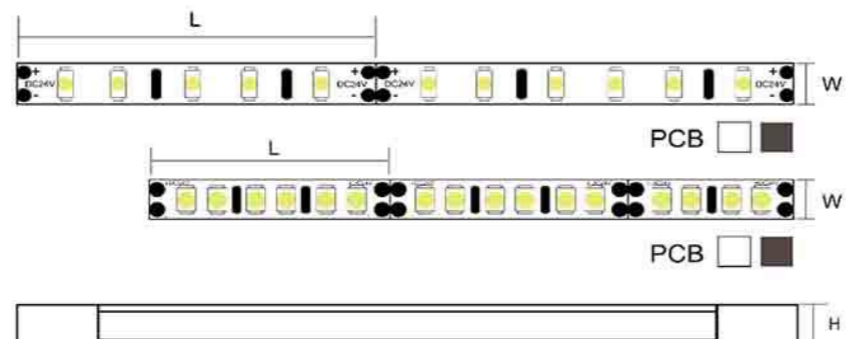



# Tunable White Series

[14.4W per/m]  
[19.2W per/m]



**DC Output:24VDC/12VDC**

**Diodes:SMD5050/3527/2835**

**Life Span:50000 Hours**

14.4/19.2W  
PER/M

120°

5M/ROII  
Packing



Product Code	Power [W/M]	Diodes Type	IP Rating	CCT-[Lumen/Meter]		Led Qty [LED/M]	CRI	PCB SIZE		
				WW	CW			Cutting points(mm)	Width (mm)	Height (mm)
				2700K	6000K					
ALSTP5050-14.4W60sR80P20	14.4	5050	IP20	640	680	60	>80	100	10	2.1
ALSTP5050-14.4W60sR90P20	14.4	5050	IP20	620	660	60	>90	100	10	2.1
ALSTP5050-14.4W60sR80P62	14.4	5050	IP62	530	560	60	>80	100	10	3.2
ALSTP5050-14.4W60sR90P62	14.4	5050	IP62	510	550	60	>90	100	10	3.2
ALSTP5050-14.4W60sR80P68	14.4	5050	IP68	530	560	60	>80	100	12.5	5.3
ALSTP5050-14.4W60sR90P68	14.4	5050	IP68	510	550	60	>90	100	12.5	5.3
ALSTP3527-19.2W120sR80P20	19.2	3527	IP20	760	800	120	>80	100	10	2.1
ALSTP2835-19.2W120sR90P20	19.2	2835	IP20	880	960	120	>90	100	10	1.4
ALSTP3527-19.2W120sR80P62	19.2	3527	IP62	630	660	120	>80	100	10	3.2
ALSTP2835-19.2W120sR90P62	19.2	2835	IP62	730	800	120	>90	100	10	3
ALSTP3527-19.2W120sR80P68	19.2	3527	IP68	630	660	120	>80	100	12.5	5.3
ALSTP2835-19.2W120sR90P68	19.2	2835	IP68	730	800	120	>90	100	12.5	5.3

**Details:**

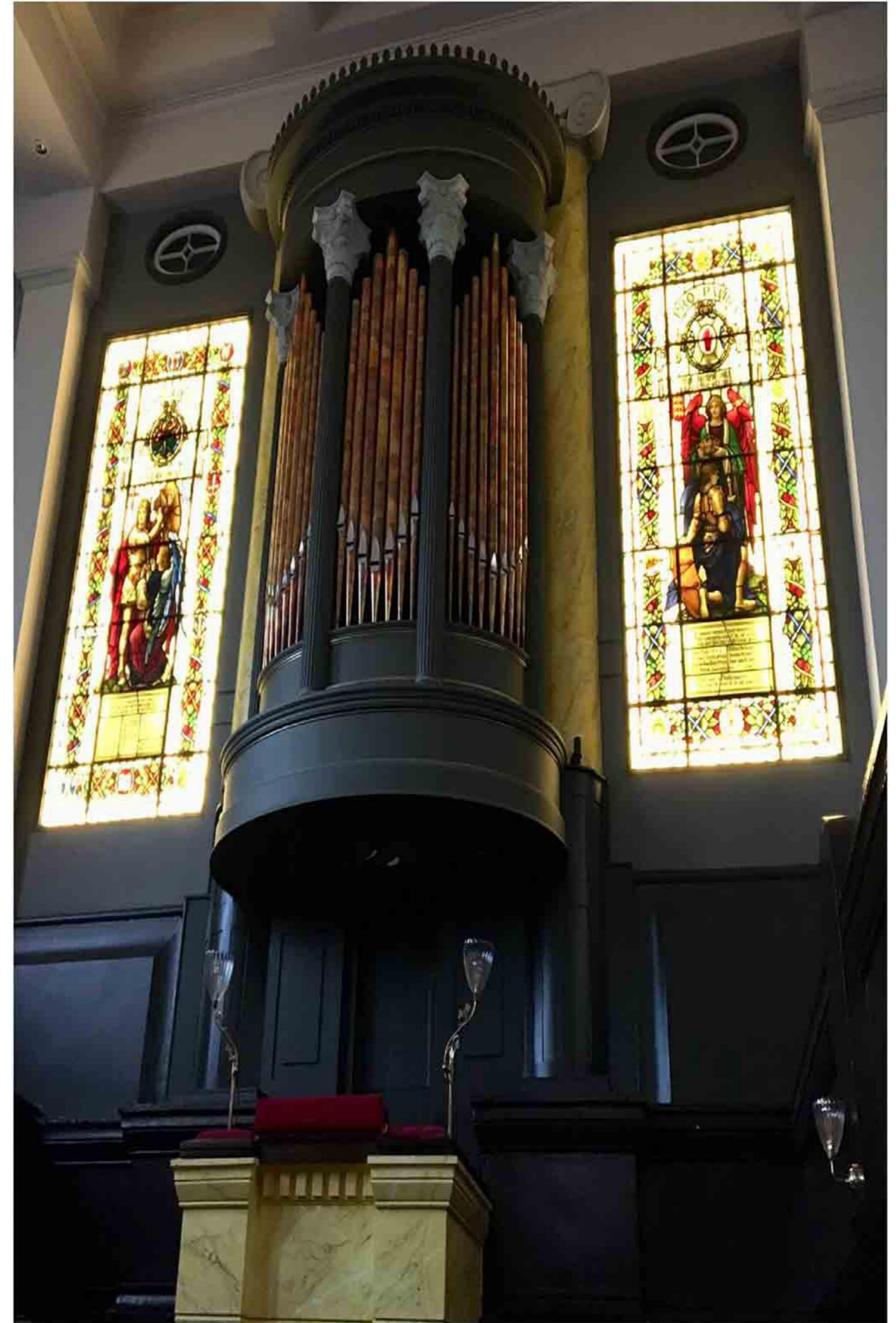
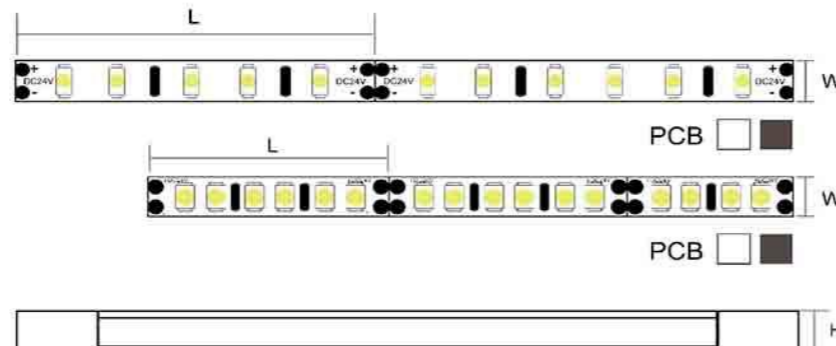



## Specialty-Side View Series

[19.2w per/m]

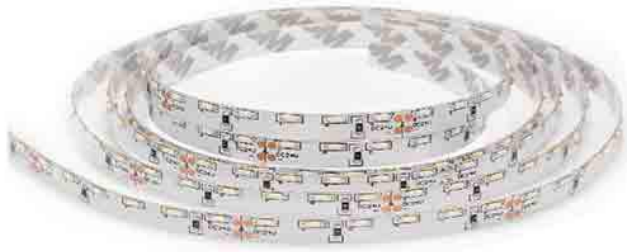

**DC Output:24VDC/12VDC**

**Diodes:SMD2835/5050**

**Life Span:50000 Hours**



Product Code	Power [W/M]	Diodes Type	IP Rating	CCT-[Lumen/Meter]				Led Qty [LED/M]	CRI	PCB SIZE		
				WW	WW	NW	CW			Cutting points(mm)	Width (mm)	Height (mm)
				2200K	2700K	4000K	6000K					
ALSTP315-4.8W60sR90P20	4.8	315	IP20	400	420	500	540	60	>90	100	8	1.2
ALSTP315-7.2W96sR90P20	7.2	315	IP20	620	650	750	810	96	>90	62.5	10	1.2

### Details:

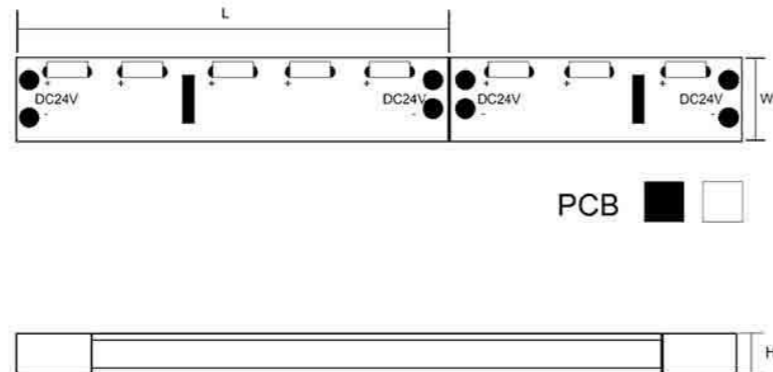
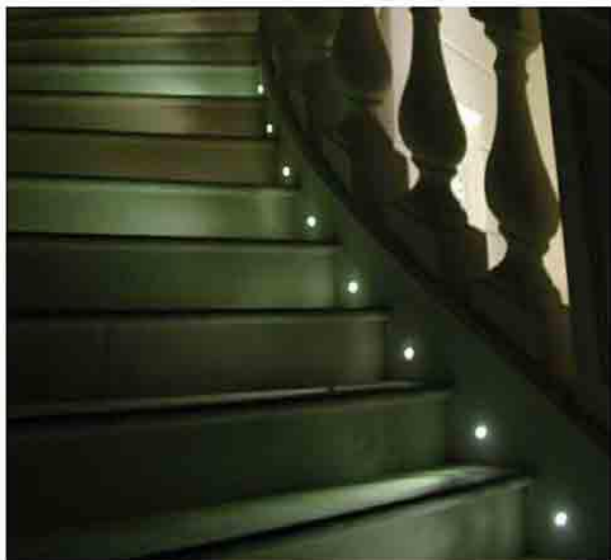



# Strip Connectors

## IP20 strip Profile connector:



**Product Name** Clip 2 pin LED strip connector  
**Production NO.** BC-N8XB-2  
**Type** strip to wire  
**Dimension** 15.4\*9.5\*4.3mm/21.6\*11.5\*4.3mm  
**Max Voltage/Current** DC36V / 5A  
**Working Environment** -10~45°C  
**Workable Wire Gauge** 20AWG / 0.52mm<sup>2</sup>  
**Workable Strip Light** 8/10mm single color IP20, <math>\leq 120\text{LEDs/M}</math>

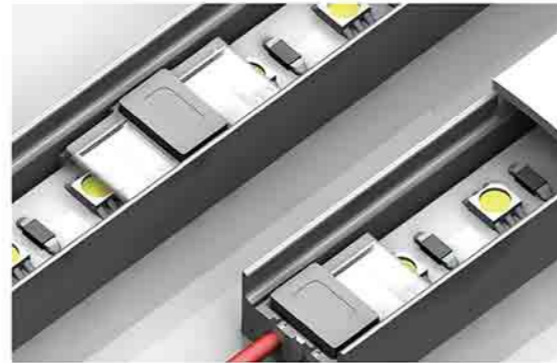

**Product Name** Clip 2 pin LED strip connector  
**Production NO.** BC-N10BB-2  
**Type** Strip to strip joint  
**Dimension** 21.6\*11.5\*4.3mm/21.6\*11.5\*4.3mm  
**Max Voltage/Current** DC36V/5A  
**Working Environment** -10~45°C  
**Workable Strip Light** 8mm/10mm single color IP20, <math>\leq 120\text{LEDs/M}</math>

## IP54/65 Strip Connector:



**Product Name** 2 Pin LED Strip Connector  
**Production NO.** DJ-N8XB-2 DJ-N8BB-2  
**Type** strip to wire strip to strip joint  
**Dimension** 24.3\*12.6\*7.7mm/19.6\*12.6\*7.7mm  
**Max Voltage/Current** DC36V/5A  
**Working Environment** -10~45°C  
**Workable Wire Gauge** 22~18AWG/0.32-0.78mm<sup>2</sup>  
**Workable Strip Light** 8mm/10mm single color IP65, <math>\leq 120\text{LEDs/M}</math>

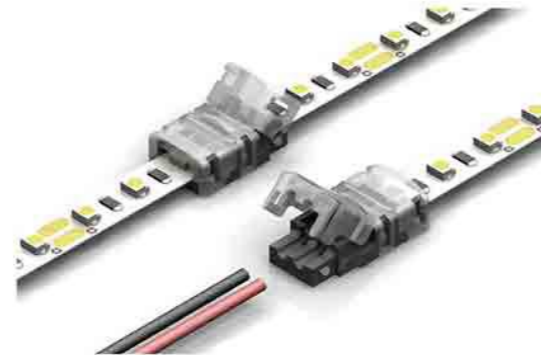

**Product Name** 2 Pin LED Strip Connector  
**Production NO.** SE-N10XB-2 SE-N10BB-2  
**Type** strip to wire strip to strip joint  
**Dimension** 24.3\*14.6\*7.7mm/19.6\*12.6\*7.7mm  
**Max Voltage/Current** DC36V / 5A  
**Working Environment** -10~45°C  
**Workable Wire Gauge** 22~18AWG / 0.32-0.78mm<sup>2</sup>  
**Workable Strip Light** 8mm/10mm single color IP54/IP65, <math>\leq 120\text{LEDs/M}</math>

## Pattern Connector NON IP:



# Strip Connectors

**Product Name** 2Solder Pad / end  
**Production NO.** FPC8-L2 FPC8-T2 FPC8-C2  
**Shape Type** L T Cross(+)  
**Dimension** 16.1\*16.1\*0.3mm 24.1\*16.1\*0.3mm 24.1\*24.1\*0.3mm  
**Max Voltage/Current** DC 36V / 3.5A  
**Working Environment** -10~45°C  
**PCB Thickness** 0.3 mm  
**Workable Strip Light** 8mm/10mm single color IP20

**Product Name** 2Solder Pad / end  
**Production NO.** FPC10-L2 FPC10-T2 FPC10-C2  
**Shape Type** L T Cross(+)  
**Dimension** 21.1\*21.1\*0.3mm 30.3\*21.1\*0.3mm 30.8\*30.8\*0.3mm  
**Max Voltage/Current** DC 36V / 3.5A  
**Working Environment** -10~45°C  
**PCB Thickness** 0.3 mm  
**Workable Strip Light** 8mm/10mm single color IP20

## IP67 strip connector:



**Product Name** Tube 2 Pin LED Strip Connector  
**Production NO.** FS-N8XB-2 FS-N8BB-2  
**Type** strip to wire strip to strip joint  
**Dimension** 26\*15\*7mm 27\*15\*7mm  
**Max Voltage/Current** DC36V / 5A  
**Working Environment** -10~45°C  
**Workable Wire Gauge** 22~18AWG / 0.32-0.78mm<sup>2</sup>  
**Workable Strip Light** 8mm/10mm single color in 10mm hollow tube IP67, <math>\leq 120\text{LEDs/M}</math>

**Product Name** Tube 4 Pin LED Strip Connector  
**Production NO.** FS-N10XB-4 FS-N10BB-4  
**Type** Strip to wire strip to strip joint  
**Dimension** 26\*17\*7mm 27\*17\*7mm  
**Max Voltage/Current** DC36V / 5A  
**Working Environment** -10~45°C  
**Workable Wire Gauge** 22~20AWG / 0.32-0.52mm<sup>2</sup>  
**Workable Strip Light** 8mm/10mm RGB in 12mm hollow tube IP67, <math>\leq 120\text{LEDs/M}</math>

## IP68 strip connector:

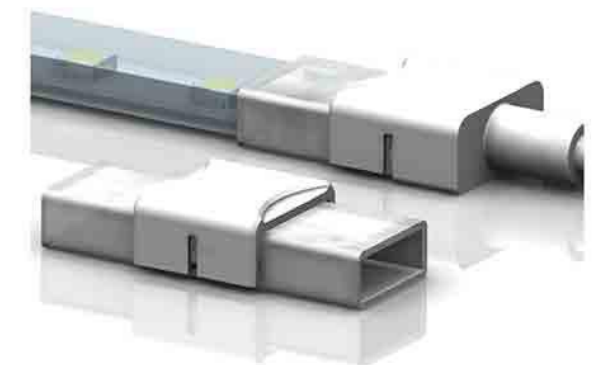

**Product Name** Solid 2 Pin LED Strip Connector  
**Production NO.** SD-N8XB-2 SD-N8BB-2 SD-N8BXB-2  
**Type** strip to wire strip to strip joint strip to strip bridge  
**Dimension** 28\*15.5\*8.5mm 40\*15.5\*8.5mm 28\*15.5\*8.5mm  
**Wire Length for Option** 200/500/1000mm 200/500/1000mm  
**Max Voltage / Current** DC36V / 5A  
**Working Environment** -10~45°C  
**Workable Wire Gauge** 20AWG / 0.52mm<sup>2</sup>  
**Workable Strip Light** 8mm/10mm single color strip light in 10mm solid tube, <math>\leq 120\text{LEDs/M}</math>

**Product Name** Solid 2 Pin LED Strip Connector  
**Production NO.** SD-N10XB-2 SD-N10BB-2 SD-N10BXB-2  
**Type** strip to wire strip to strip joint strip to strip bridge  
**Dimension** 28\*17.5\*8.5mm 40\*17.5\*8.5mm 28\*17.5\*8.5mm  
**Wire Length for Option** 200/500/1000mm 200/500/1000mm  
**Max Voltage / Current** DC36V/5A  
**Working Environment** -10~45°C  
**Workable Wire Gauge** 20AEG/0.52mm<sup>2</sup>  
**Workable Strip Light** 8mm/10mm single color strip light in 12mm solid tube, <math>\leq 120\text{LEDs/M}</math>





**Product Code:**  
ALP002-R  
**DESCRIPTION:**  
PMMA-O(Opal,White)  
PMMA-C(Clear Frosted)  
PC-O(Opal,White)  
PC-C(Clear Frosted)

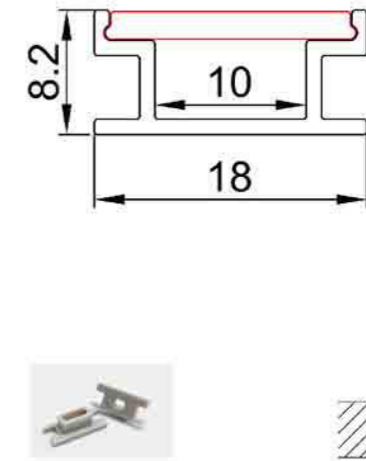

**Product Code:**  
ALP009  
**DESCRIPTION:**  
PMMA-O(Opal,White)  
PMMA-C(Clear Frosted)

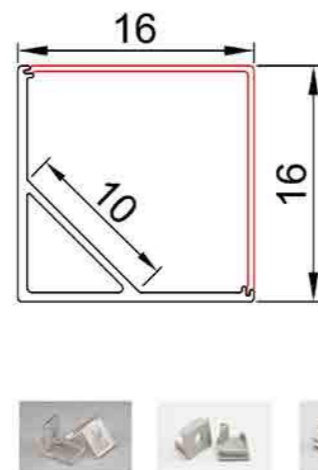

**Product Code:**  
ALP005  
**DESCRIPTION:**  
PMMA-O(Opal,White)  
PMMA-C(Clear Frosted)

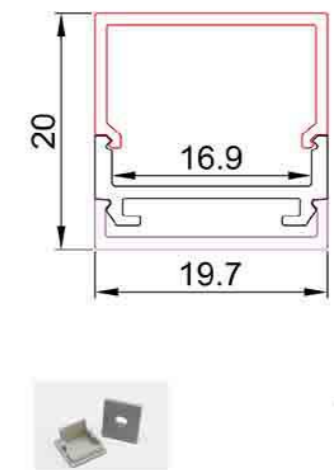

**Product Code:**  
ALP011  
**DESCRIPTION:**  
PMMA-O(Opal,White)  
PMMA-C(Clear Frosted)

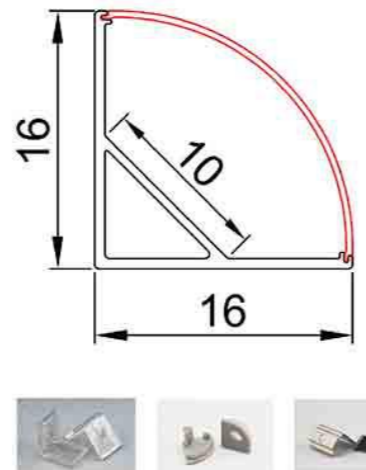

**Product Code:**  
ALP006  
**DESCRIPTION:**  
PMMA-O(Opal,White)  
PMMA-C(Clear Frosted)

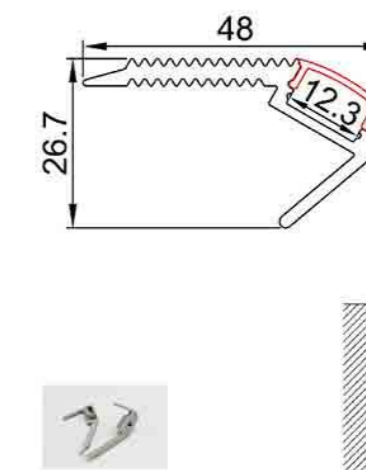

**Product Code:**  
ALP022  
**DESCRIPTION:**  
PC-O(Opal,White)  
PC-C(Clear Frosted)