

Recessed LED inground lamp

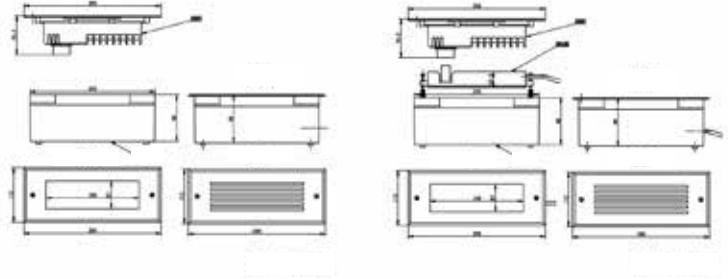

INDUCTION COUPLING



### Product Spec:

Product Code	Dimension L*W[mm]	Power [W]	Input Voltage [V]	Efficiency [lm/W]	Color Temp[K]	CRI	Beam Angle	IP	LED Chip
AL-ILLBRK280-6w	Φ280*112*100mm	6W	AC220-240V	80lm/W	3000K-6500K	≥80	120°	IP65	CREE 3535
AL-ILLBRK280-9W	Φ280*112*100mm	9W	AC220-240V	80lm/W	3000K-6500K	≥80	120°	IP65	CREE 3535



## Installation instructions

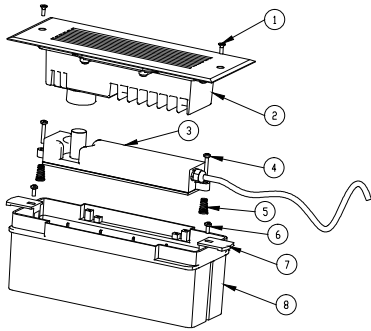

1. Punch the wall of the installation wall (guarantee ⑧ can be placed in the correct position), then put it into ⑧, and ensure that ⑦ is in full contact with the wall during installation (ensure that ⑧ is level with the mounting surface).

2. Make sure ⑧ was installed horizontally, solidify with silicon gel. After the curing of the binder, keep the following installation steps. discharge ⑥ and ⑦.

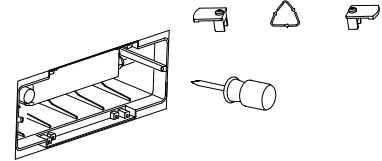
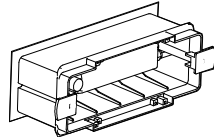

3. Connect the ⑤ and main line wires to ensure that the interface is waterproof and then put it into the ⑧.

4. Take out ②, put it into ③, make ② fully contact with ③.

5. Take out ①, use screw-driver to fasten ② and ③, thus installation is over, Power detection.

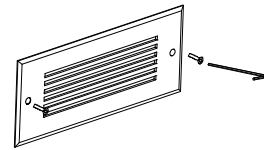
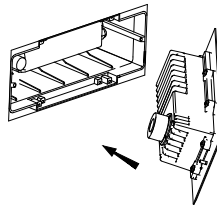
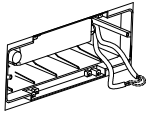

Strictly follow the installation requirements, remove the setting tabs after installing the embedded part (⑥ and ⑦).

Follow installation instructions carefully. Ensure all below ground termination is totally sealed. Do not shorten the cable lengths provided on the fixture. Ensure all power is off during installation until circuit is complete.

## IP68 Connector:

**AL-68CT**

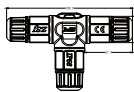

**AL-68CS**

